

# Data Sheet



Article number: 03553035

Description: Fluro hydraulic rod end FPR 35U

## Measures

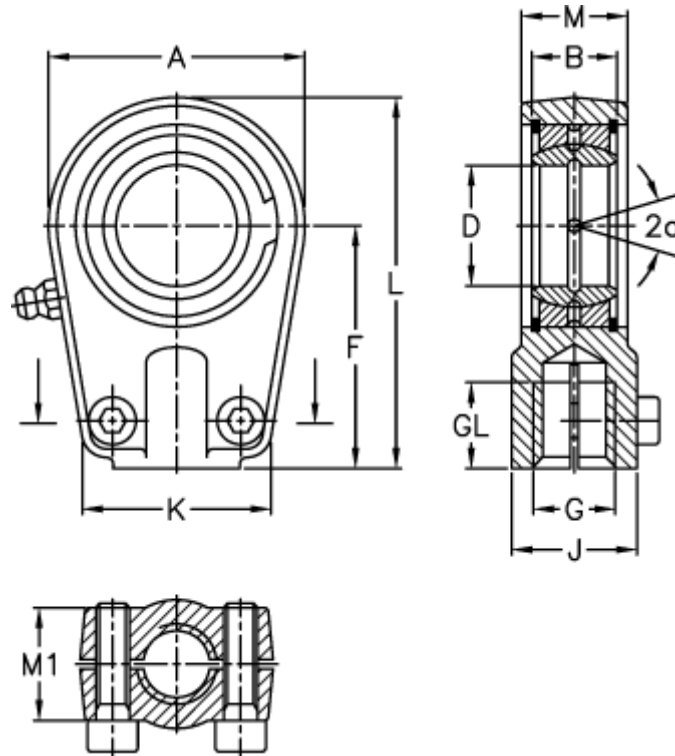

A	= 78	J	= 40
a (degrees)	= 6	K	= 66
B	= 25	L	= 112
D	= 35	M	= 30
Dynamic load C (kN)	= 80	M1	= 28
F	= 70	Static load C0 (kN)	= 153
g	= M28x1,5	Torque (N m)	= 49
GL	= 29	Weight	= 1150